

High voltage, high current Darlington transistor array

BA12001B / BA12003B / BA12003BF / BA12004B

The BA12001B, BA12003B, BA12003BF, and BA12004B are high voltage, high current, high sustain voltage transistor arrays consisting of seven circuits of Darlington transistors.

Because it incorporates built-in surge-absorbing diodes and base current-control resistors needed when using inductive loads such as relay coils, attachments can be kept to a minimum.

With an output sustain voltage as high as 60V and an output current (sink current) of 500mA, this product is ideal for use with various drivers and as an interface with other elements.

●Applications

Drivers for LEDs, lamps, relays and solenoids

Interface with other elements

●Features

- 1) High output current. ($I_{OUT}=500\text{mA Max.}$)
- 2) High output sustain voltage. ($V_{OUT}=50\text{V Max.}$)
- 3) Seven Darlington transistors built in.
- 4) Built-in surge-absorbing clamp diode.

(Note : Refer to the "Reference items when using in application.")

●Block diagram

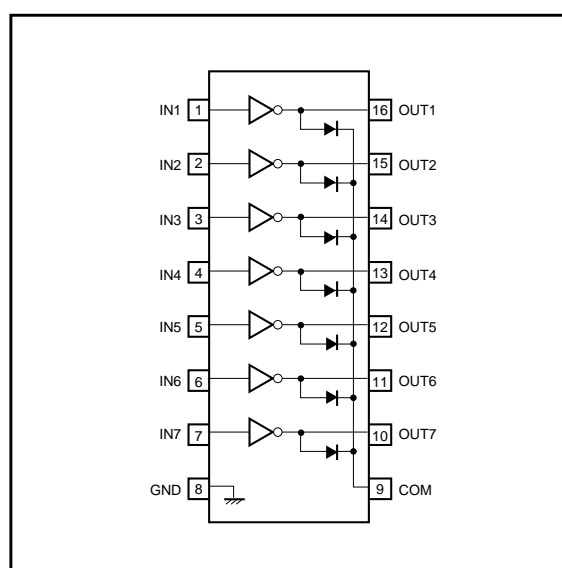

BA12001B / BA12003B / BA12003BF / BA12004B

Standard ICs

●Internal circuit configuration

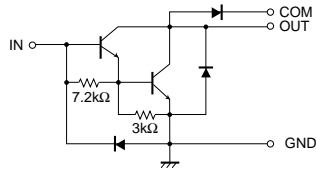

Fig.1 BA12001B

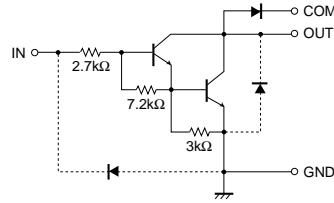

Fig.2 BA12003B / BF

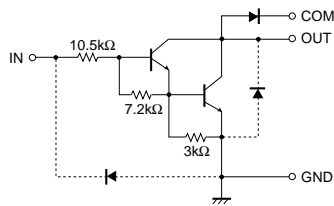

Fig.3 BA12004B

●Absolute maximum ratings (Ta=25°C)

Parameter		Symbol	Limits	Unit
Power supply voltage		V _{CE}	60	V
Input voltage	other than BA12001B	V _{IN}	-0.5~+30	V
Input current	BA12001B	I _{IN}	25	mA / unit
Output current		I _{OUT}	500	mA / unit
Ground pin current		I _{GND}	2.3*1	A
Power dissipation	DIP package	P _d	1250*2	mW
	SOP package		625*3	
Diode reverse voltage		V _R	60	V
Diode forward current		I _F	500	mA
Operating temperature		T _{opr}	-25~+75	°C
Storage temperature		T _{stg}	-55~+150	°C

*1 Pulse width ≤ 20ms, duty cycle ≤ 10%, same current for all 7 circuits

*2 Reduced by 10mW for each increase in Ta of 1°C over 25°C .

*3 Reduced by 50mW for each increase in Ta of 1°C over 25°C .

●Recommended operating conditions (Ta=25°C)

Parameter	Symbol	Min.	Typ.	Max.	Unit	Conditions
Output current	I _{OUT}	-	-	350	mA	Fig.9, 10
Power supply voltage	V _{CE}	-	-	55	V	-
Input voltage (excluding BA12001B)	V _{IN}	-	-	30	V	-
Input current (BA12001B only)	I _{IN}	-	-	25	mA / unit	-

BA12001B / BA12003B / BA12003BF / BA12004B

Standard ICs

●Electrical characteristics (Ta=25°C)

Parameter		Symbol	Min.	Typ.	Max.	Unit	Conditions
Output leakage current		I _L	–	0	10	μA	V _{CE} = 60V
DC current transfer ratio		h _{FE}	1000	2400	–	V	V _{CE} = 2V, I _{OUT} = 350mA
Output saturation voltage		V _{CE(sat)}	–	0.94	1.1	V	I _{OUT} = 100mA, I _{IN} = 250μA
				1.14	1.3		I _{OUT} = 200mA, I _{IN} = 350μA
				1.46	1.6		I _{OUT} = 350mA, I _{IN} = 500μA
Input voltage	BA12003B / BF	V _{IN}	–	1.75	2	V	V _{CE} = 2V, I _{OUT} = 100mA
	BA12004B			2.53	5		
	BA12003B / BF	V _{IN}	–	1.91	2.4	V	
	BA12004B			2.75	6		
	BA12003B / BF	V _{IN}	–	2.17	3.4	V	
	BA12004B			3.27	8		
Input current	BA12003B / BF	I _{IN}	–	0.90	1.35	mA	V _{IN} = 3.85V
	BA12004B			0.39	0.5		V _{IN} = 5V
Diode reverse current		I _R	–	0	50	μA	V _R = 60V
Diode forward voltage		V _F	–	1.73	2	V	I _F = 350mA
Input capacitance		C _{IN}	–	30	–	pF	V _{IN} = 0V, f = 1MHz

Note: Input voltage and input current for BA12001 vary based on external resistor.

●Measurement circuits

(1) Output leakage current I_L

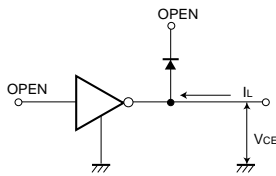

(2) DC current transfer ratio
Output saturation voltage $h_{FE} = \frac{I_o}{I_i}$
 $V_{CE(sat)}$

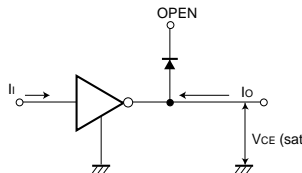

(3) Input voltage V_{IN}

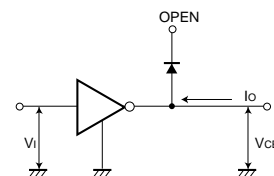

(4) Input current I_{IN}

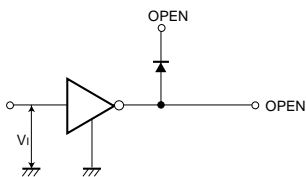

(5) Diode reverse current I_R

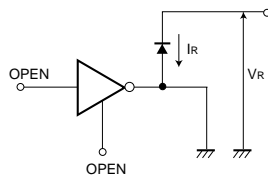

(6) Diode forward voltage I_F

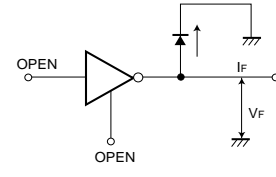

(7) Input capacitance C_{IN}

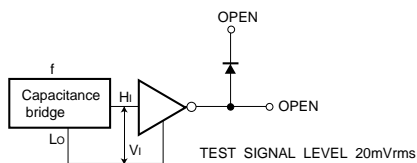

Fig.4

●Application example

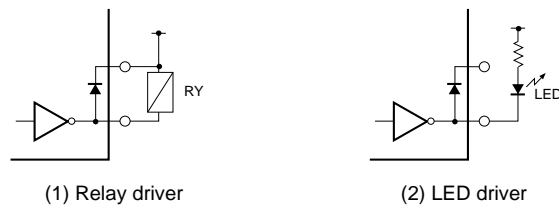

Fig.5

●Application notes

The BA12001B is a transistor array which can be directly coupled to a general logic circuit such as PMOS, CMOS, or TTL.

A current limiting resistor needs to be connected in series with the input.

The BA12003B / BF can be coupled directly to TTL or CMOS output (when operating at 5V). In order to limit the input current to a stable value, resistors are connected in series to each of the inputs.

The BA12004B is designed for direct coupling to CMOS or PMOS output using a 6 to 15V power supply voltage. In order to limit the input current to a stable value, resistors are connected in series to each of the inputs.

The load for each of these products should be connected between the driver output and the power supply. To protect the IC from excessive swing voltage, the COM pin (Pin 9) should be connected to the power supply.

Fig.6 shows the configuration of the on-chip diode for surge absorption.

In the construction of the surge-absorbing diode, there is an N-P junction between the N-layer (N-well + BL) and the substrate (P-sub) so that when the diode is on, current flows from the output pin to the substrate. In terms of the vertical construction, this diode is configured similar to a PNP transistor. When using the surge-absorbing diode, take appropriate measures regarding the thermal characteristics of the design considering the current that will be handled.

Also, if motor back-rush current or other conditions that will result continued surge current to flow to the surge-absorbing diode can be foreseen, we strongly recommend connecting a Schottky barrier diode (or other type of diode with a low forward voltage) in parallel with the surge-absorbing diode to construct a bypass route for the surge current.

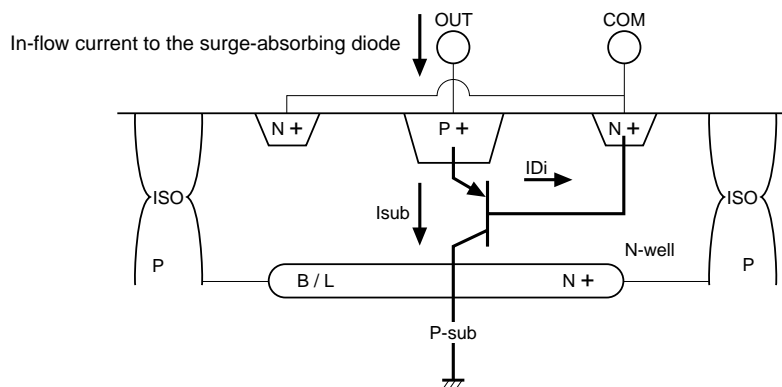

Fig.6 Vertical construction of the surge-absorbing diode

BA12001B / BA12003B / BA12003BF / BA12004B

Standard ICs

●Electrical characteristic curves

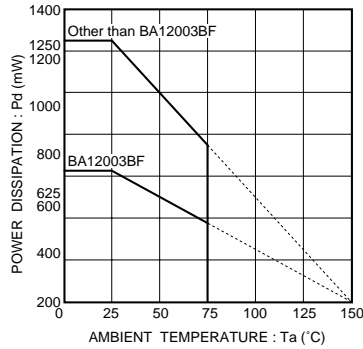

Fig.7 Power dissipation vs. ambient temperature

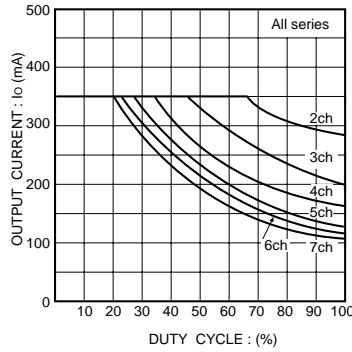

Fig.8 Output conditions (I)

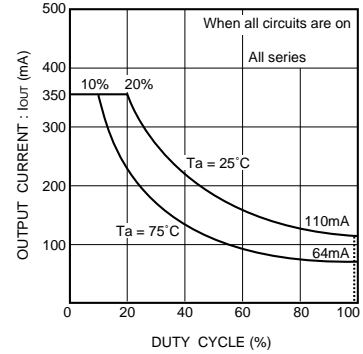

Fig.9 Output conditions (II)

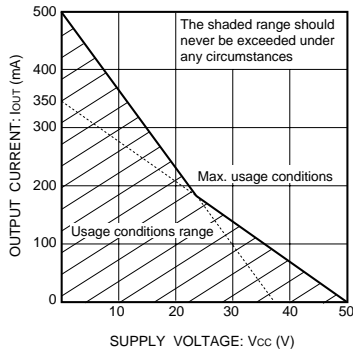

Fig.10 Usage conditions range per circuit

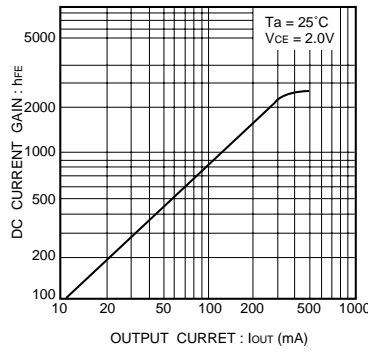

Fig.11 DC current transfer ratio vs. output current

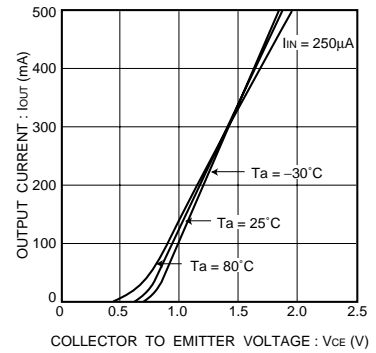

Fig.12 Output current vs. voltage between collector and emitter

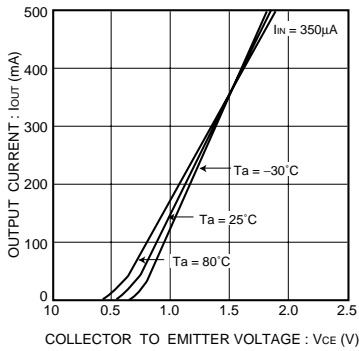

Fig.13 Output current vs. voltage between collector and emitter

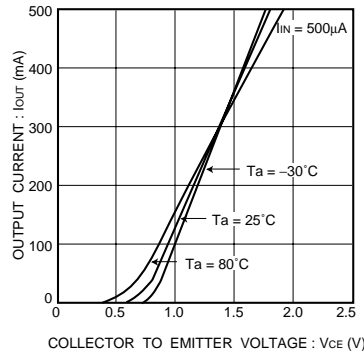

Fig.14 Output current vs. voltage between collector and emitter

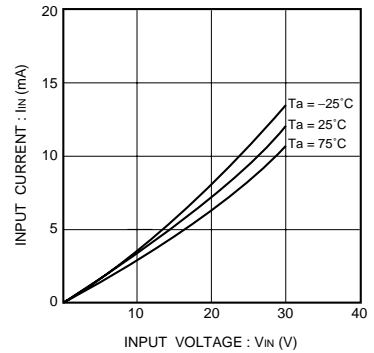

Fig.15 Input current vs. input voltage (BA12003B / BF)

BA12001B / BA12003B / BA12003BF / BA12004B

Standard ICs

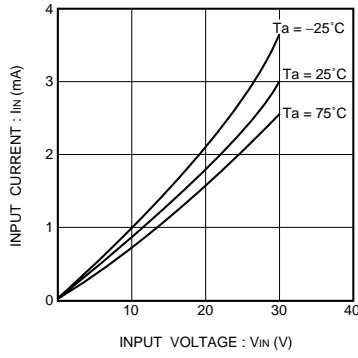

Fig.16 Input current vs. input voltage (BA12004B)

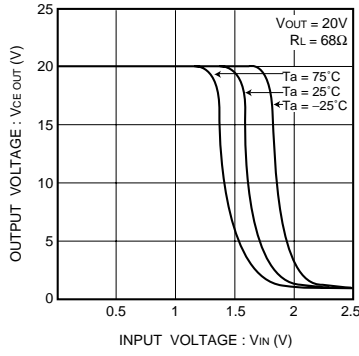

Fig.17 Output voltage vs. input voltage (BA12003B / BF)

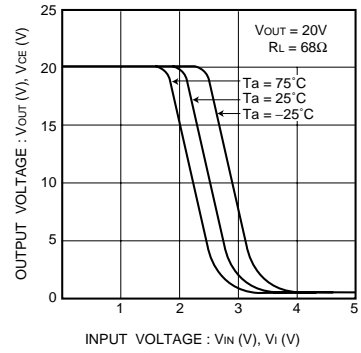

Fig.18 Output voltage vs. input voltage (BA12004B)

External dimensions (Units : mm)

